



# Omni 20+ User Manual

# POWER YOUR NEXT ADVENTURE

For more information visit our **support** page at [www.omnicharge.co/support](http://www.omnicharge.co/support)

# BEFORE USING

## Calibrate the battery

To make sure the battery percentage reading is correct, make sure to calibrate the battery within the first seven days of receiving the product.

---

It's easy to do. Follow these steps:

1. Fully discharge Omnicore until the screen turns off. Press the Power Button and you should see an empty battery icon on the screen.



2. Fully charge your Omnicore to 100% to finish the calibration.

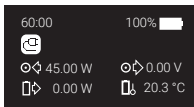

*Note: The Omnicore battery needs to be recharged at least every 6 months to avoid over depletion. Failure to do so can cause the battery to malfunction and is not covered by warranty.*

# PORTS AND BUTTONS

**Note:** For optimal wireless charging, place phone horizontally towards the back of the Omnicharge.

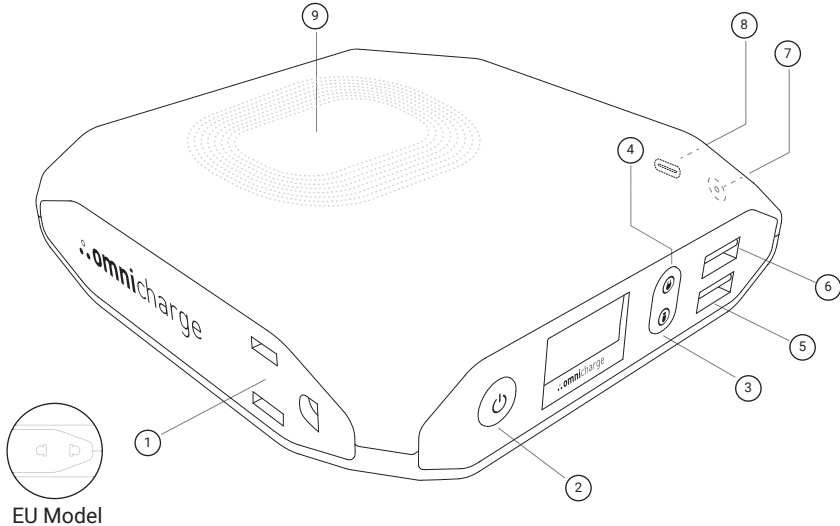

EU Model

1. AC Outlet
2. Power and Menu Button
3. USB Button
4. AC Outlet Button

5. Quick Charge USB (QC 3.0 Compatible)
6. 5V/3A USB-A Port
7. DC Input/Output (5.5 x 2.1mm Barrel Port)
8. USB-C Input/Output
9. Wireless Charging

# BUTTON FUNCTIONS

## PRIMARY CONTROLS



- Long press to power on
- Long press to power off



- On/Off AC Outlet
  - On/Off USB Ports
- 

## MENU CONTROLS



- Double press to enter the menu
- Quick press to select



- Move Up
  - Move Down
- 

# SCREEN

## OLED screen with real time metrics

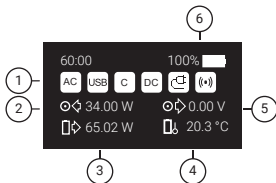

1. Status Icons
2. Power Input (watts)
3. Battery Power Output (watts)
4. Battery Temperature
5. DC Output Voltage
6. Battery Percentage

*Note: When you are pass-through charging, the battery output field will show a lower value and can even show 0W output, since the output field is showing how much power is output from the battery and not how much is output from the port.*

---

# SCREEN ICONS



## AC OUTPUT

AC outlet is activated.



## HVDC OUTPUT

HVDC (high voltage DC) is activated.



## USB-C OUTPUT

60W USB-C output is activated.



## ADJUSTABLE DC OUTPUT

Adjustable 5V-25V DC output is activated.



## LOW TEMPERATURE PROTECTION

Battery's temperature is too low, the charging circuit is shut off.



## LOW POWER PROTECTION (ONLY DURING PASS-THROUGH)

Occurs when outgoing power is higher than incoming power and battery is empty. Omnicharge will cut off the outgoing power until a sufficient battery level has been reached.



## OVERPOWER PROTECTION

Device is drawing too much power. Omnicharge will limit or cut off the output power.



## OVERHEATING PROTECTION

Battery temperature is too high. Omnicharge will limit or cut off its input and output power.



## OVERVOLTAGE PROTECTION

Barrel input voltage exceeds the 36V limit. Input charging circuit is shut off.



## USB OUTPUT

USB ports are turned on.



## CHARGING INPUT

Your Omnicharge is being charged.



## OPTIMAL CHARGING

Charging at maximum power.



## SOLAR CHARGING

Charging from solar power.



## Wireless Charging

Wireless charging is active.

# MENU NAVIGATION

## 1. DC OUT

Turn on DC output and set the voltage and amperage.

## 2. WALL SOCKET

Choose whether the AC outlet will output 120V AC or 150V HVDC

## 3. USB

Choose whether your USB-A ports are on or off when you turn on your Omnicarge. The default setting is on.

## 4. SCREEN OFF TIMER

Set the screen auto shut-off time here. The default setting is 5 min.

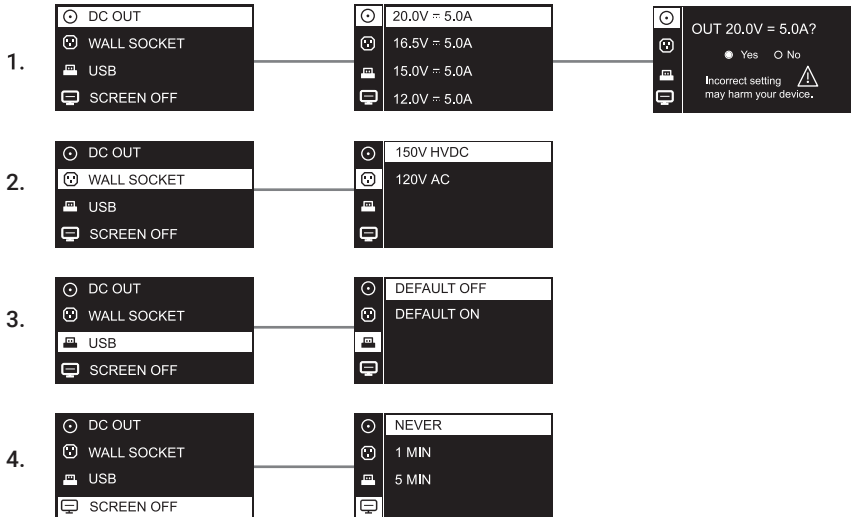

# MENU NAVIGATION

## 5. AUTO SHUT DOWN

Set the power auto shut-off time here. The default setting is 5 min.

## 6. TEMPERATURE

Choose whether your temperature is displayed in celcius or fahrenheit

## 7. BUTTON LIGHT

Choose whether the button lights are on or off. The default setting is on.

## 8. TIME REMAINING

Choose whether the time remaining is displayed





# MENU NAVIGATION

## 9. LANGUAGE

Choose the screen language

## 10. FACTORY RESET

Reset the Omniccharge to the factory settings

## 11. ABOUT

Find the model name, capacity, firmware version, and serial number information here.

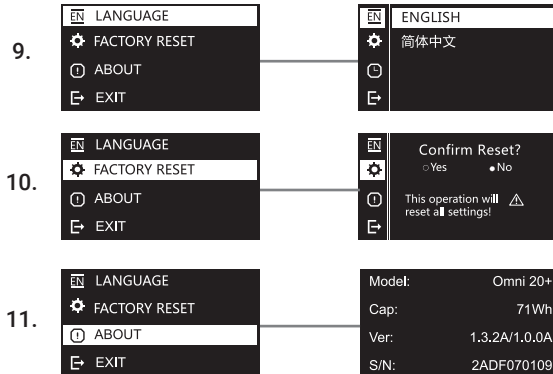

# AC OUTLET

Max output power: 100W

To change the AC output mode, double press the Power Button to enter the menu and select Wall Socket.

---

1. Choose 120V AC/150V HVDC mode in the menu



## Note:

Only choose 150V HVDC if you are using a switch mode power supply, such as a laptop's AC power adapter. Check our [support page at www.omnicharge.co](http://www.omnicharge.co) for more detailed information.

---

2. When AC/HVDC is active, the following icons should appear on the screen

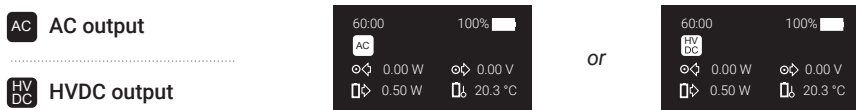

3. Power any device.



Laptop



TV



Drone



DSLR



Projector



And more

# DC OUTPUT

5V - 25V with 0.1V Accuracy, up to 5A (100W max)

The DC output feature can directly charge your laptop without needing your laptop charger.

**Warning:** Before using DC Output make sure you know the correct voltage for your laptop.  
**Using the wrong voltage can damage your device.**

**Note:** For more information visit our [support page](http://www.omnicharge.co/support) at [www.omnicharge.co/support](http://www.omnicharge.co/support)

Set voltage and amperage through the menu

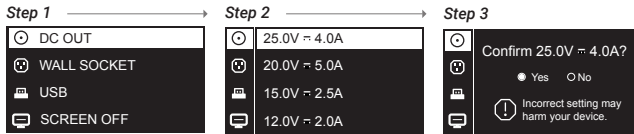

Omnicharge keeps 4 voltage presets. You can press and hold the power button while selecting a preset to customize the voltage and amperage.

Once active, the DC icon will appear.

**DC** Adjustable DC output

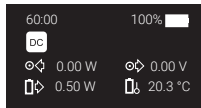

Power your device through the DC port.

DC to Surface Cable



DC to MagSafe 2 Cable

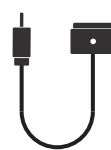

You can purchase additional DC cables from our website. For more information about available accessories, please visit [www.omnicharge.co/products](http://www.omnicharge.co/products)

# USB-C PORT

USB-C port max output: 60W

The USB-C port is plug-and-play. Plug your USB-C device into the USB-C port to start charging

**Note:** *If your USB-C output does not start charging, try to reconnect the USB-C cable.*

Power any USB-C device.



Action Camera



Nintendo Switch



Smartphone



Tablet



Laptop



And more

---

# RECHARGING FROM THE USB-C PORT

USB-C port max input: 45W

Fully recharge in 3 hours

Plug in a USB-C wall charger and it will start recharging the Omni 20+.

**Note:** *If the Omnicharge does not detect incoming power, try to plug in your USB-C charger while the Omnicharge is turned off. Once charging has started, you can power on the Omnicharge to utilize pass-through charging.*

# USB-A PORTS

5V==3A, 9V==2A, 12V==1.5A QC3.0 compatible

1. Choose whether the USB output is on or off by default.



# RECHARGING FROM THE BARREL PORT

DC Input 5V - 25V, Up to 3A (2W - 45W)

## Charging your Omnicharge

Use any AC wall charger, or other power adapters like your laptop charger to recharge your Omnicharge.

*Note: Make sure the output voltage of your adapter falls within 5V - 25V range.  
The Omni 20+ only accepts 5.5 x 2.1mm barrel plugs.*



AC wall charger  
3 hours



USB sources  
5-7 hours



Solar (up to 45W)  
3-6 hours



Car power port (12V)  
3 hours



Laptop adapter  
3 hours

# TECHNICAL SPECIFICATION

## GENERAL

Weight: 1.35 lbs (611 g)

Dimension: 5.0"x 4.8"x 1.1"(12.7 x 12.2 x 2.7 cm)

---

## USB-C

Bidirectional Input/output charging

Input: USB-PD, 5V~20V, up to 3A, 45W max

Output: 5V==3A, 9V==3A, 12V==3A, 15V==3A, 20V==3A, up to 3A, 60W max

---

## USB-A Output

Port1: QC 3.0, 5V==3A, 9V==2A, 12V==1.5A

Port2: QC 3.0, 5V==3A, 9V==2A, 12V==1.5A

---

## DC Port

Bidirectional Input/output charging

Input: 5~25V, up to 3A, 45W max

Output: 5~25V, up to 5A, 100W max

---

## AC PORT

120V AC, 60Hz, 100W max US version

230V AC, 50Hz, 100W max EU version

---

## WIRELESS CHARGING

Output: 10W

---

## CAPACITY

6 cells, 70Wh max at 3.7V

---

## OPERATING ENVIRONMENT

Temperature 0°C-40°C

Humidity 30-70%

Altitude ≤2000m

---

## MADE IN CHINA

© 2021 Omniccharge.

❖ **omni**charge® is a trademark of Omniccharge Inc.

***THANK YOU***

[www.omnicharge.co](http://www.omnicharge.co)

# CUSTOMER SUPPORT

All Omnicharge products have gone through quality inspection. If you find your Omnicharge or any Omnicharge accessory is experiencing or demonstrating any abnormal behavior, immediately stop all product use and contact us at [support@omnicharge.co](mailto:support@omnicharge.co).

---

## FOLLOW US



<https://www.facebook.com/omnicharge>



<https://www.instagram.com/omnicharge>



<https://www.youtube.com/c/omnicharge>



[https://twitter.com/omni\\_charge](https://twitter.com/omni_charge)

---